

CAMPANA INDUSTRIAL LED 100W IP65

ESPECIFICACIONES:

VOLATJE: AC100-240V (50/60Hz)

POTENCIA: 100W

EFICIENCIA: ≥ 0.9

TIPO BASE: HOOK

MATERIAL: ALUMINIO

ANGULO DE ILUMINACION: 90°

TEMPERATURA DE COLOR: 6000K

INDICE DE REPRODUCCION DEL COLOR: RA85

LUMENES: 9000LM

LUX:

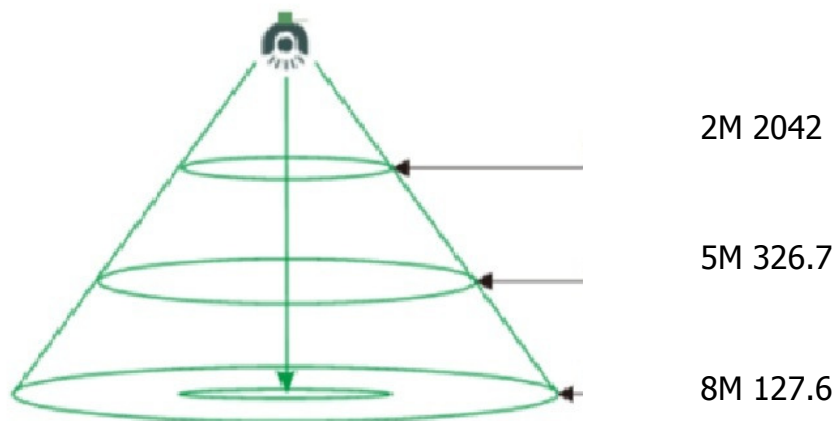

MEDIDAS:

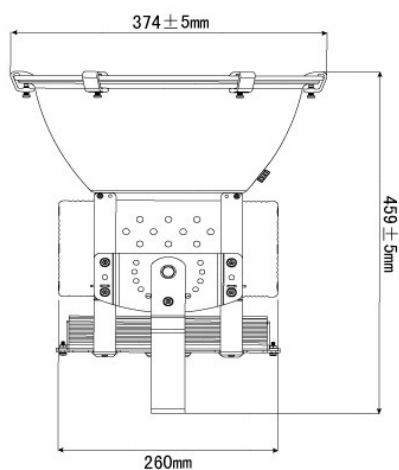

IMAGENES:

